

Optics Manual

Correct Handling of Laser Optics

Service Instructions

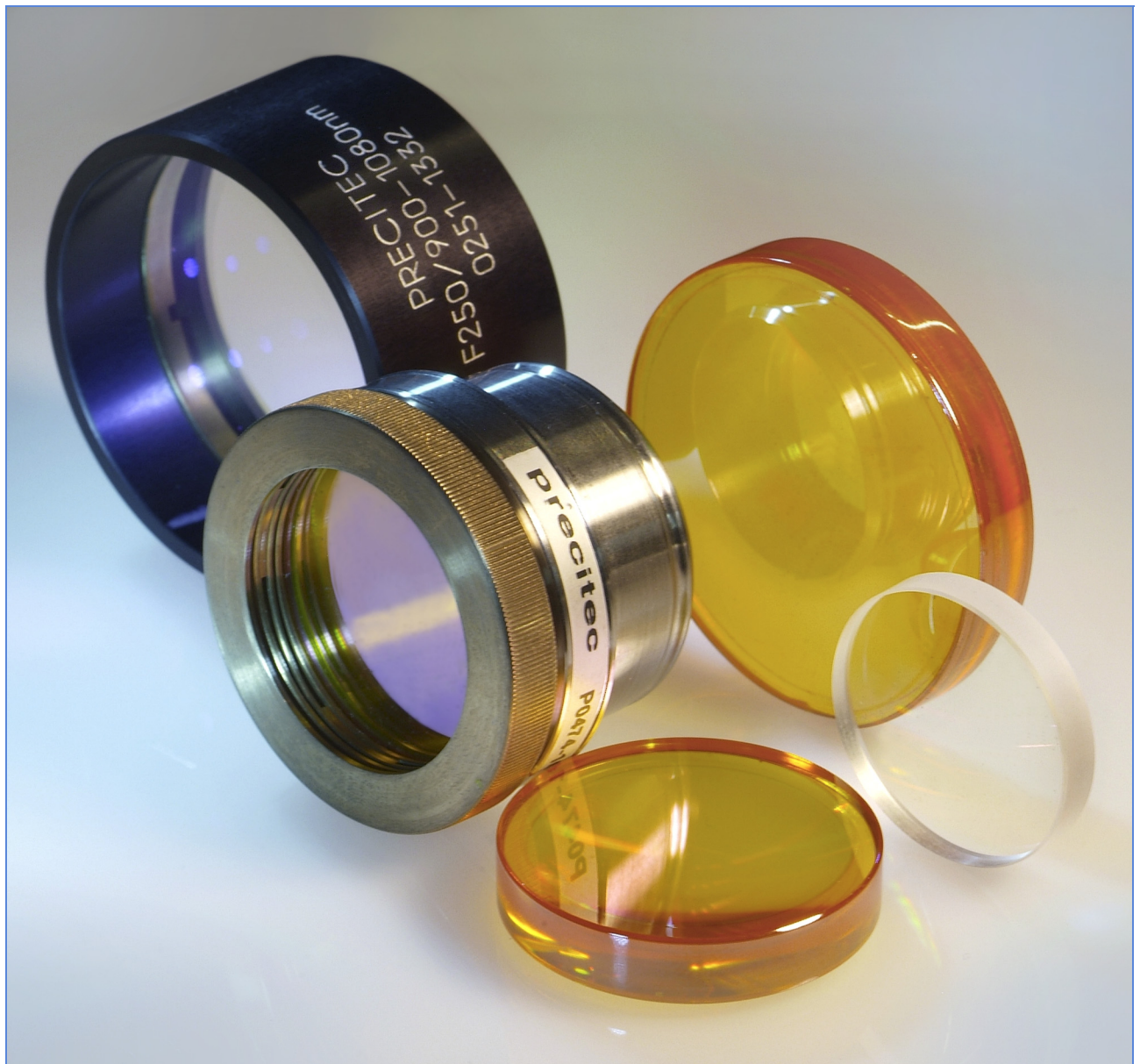

This documentation is protected by copyright law for Precitec GmbH & Co. KG and must not be reproduced without the prior written consent of Precitec or used against the due interest of Precitec. It is intended exclusively for internal use associated with setup and service work. Any other use is not permitted. Any communication of this documentation to a third party requires the prior express written permission of Precitec GmbH & Co. KG.

We reserve the right to change technical details of the descriptions, information and illustrations in this documentation.

Lasermatic, Laser Path Finder, LWM, the Precitec logo and precitec are registered trademarks in Germany and/or other countries.

Printed in the Federal Republic of Germany.

Responsible for the content

Translation of the original instructions

Precitec GmbH & Co. KG
Draisstraße 1
D - 76571 Gaggenau - Bad Rotenfels

Tel.: +49 (0)7225 684-0
Fax: +49 (0)7225 684-900
E-mail: precitec@precitec.de

Document History

Date	Chapter / page	Topic, revision, action taken
03/2018	Equipment, Cleaning the optics	Bellows blower removed
04/2014	System description Installing and removing optical components Appendix	Optic basics Protective window connection Fibre plug / fibre socket: <ul style="list-style-type: none"> • excessive radiation / overheating • optimum sealing Subsidiaries

Notes





Table of contents

1 Basic Safety Notes 1 - 1

- 1.1 Designated use 1 - 1
- 1.2 Obligations of operator and personnel 1 - 1
- 1.3 Safety measures 1 - 1
- 1.4 Meaning of symbols and notes 1 - 2
- 1.5 Risk of injury from laser radiation 1 - 2

2 Safety notes for optics material 2 - 3

- 2.1 Optical components made from zinc selenide (ZnSe) 2 - 3
 - 2.1.1 Damaged optical components made from zinc selenide (ZnSe) 2 - 3
 - 2.1.2 First Aid measures 2 - 3
 - 2.1.3 Action to be taken following an accident 2 - 3
- 2.2 Optical components with coatings containing thorium 2 - 4
 - 2.2.1 Damaged coating 2 - 4
 - 2.2.2 Broken optical components 2 - 4

3 Safety notes for cleaning agents 3 - 5

- 3.1 Ethanol (denaturated alcohol, min. 99.5%) 3 - 5
- 3.2 Acetone or propan-2-ol (isopropanol) 3 - 5

4 System description 4 - 7

- 4.1 Optical components - Function and principle 4 - 7
 - 4.1.1 Beam path in the laser head 4 - 7
 - 4.1.2 Laser fibre and fibre socket 4 - 8
 - 4.1.3 Collimator 4 - 8
 - 4.1.4 Lens 4 - 9
 - 4.1.5 Protective window 4 - 9
- 4.2 Optics material 4 - 10
- 4.3 Optics coating 4 - 10
- 4.4 Optic basics 4 - 11
 - 4.4.1 Aspect ratio / focus diameter 4 - 11
 - 4.4.2 Rayleigh length 4 - 12
 - 4.4.3 Beam parameter product 4 - 13

5 Contaminated or defective optics 5 - 15

- 5.1 Aids for finding the cause 5 - 15
 - 5.1.1 Contaminated protective window 5 - 15
 - 5.1.2 Contaminated lens 5 - 16

- 5.1.3 Damaged lens - Part 1 5 - 17
- 5.1.4 Damaged lens - Part 2 5 - 18
- 5.1.5 Damaged lens - Part 3 5 - 19
- 5.1.6 Contaminated fibre end 5 - 20
- 5.1.7 Contaminated collimator 5 - 21

6 Equipment 6 - 23

6.1 Working environment and auxiliary material 6 - 23

- 6.1.1 Flow Box 6 - 23
- 6.1.2 Gloves, protective glasses, pad 6 - 24
- 6.1.3 Illumination, background 6 - 25
- 6.1.4 Compressed air 6 - 26
- 6.1.5 Cleaning pads (swabs) 6 - 26
- 6.1.6 Cleaning agents 6 - 27
- 6.1.7 Protective film, storage box 6 - 27
- 6.1.8 Disposing of cleaning material 6 - 27
- 6.1.9 Precitec Service Case 6 - 28
- 6.1.10 Unsuitable cleaning agents and auxiliary material 6 - 28

7 Cleaning the optics 7 - 29

7.1 Recommendations 7 - 29

- 7.1.1 Step 1: Removing loose dirt 7 - 29
- 7.1.2 Step 2: Removing firmly adhering dirt 7 - 30

8 Installing and removing optical components 8 - 31

- 8.1 Protective window 8 - 31
- 8.2 Lens 8 - 33
- 8.3 Removing and installing the laser fibre 8 - 34
- 8.4 Removing and installing the collimator 8 - 36

9 Appendix 9 - 39

9.1 Basic technical information 9 - 39

- 9.1.1 Conversion of Units 9 - 39
- 9.1.2 Translation of technical terms 9 - 39

1 Basic Safety Notes

These operating instructions are intended for trained specialist personnel in laser material processing.



Observe all instructions and guidelines in this documentation.

In addition, accident prevention regulations and instructions applicable to the area of use must be observed.

1.1 Designated use

The laser head has been designed for integration into a laser machine. It is used for laser cutting and welding metals with CO₂, solid-state and diode lasers.

Only use the product in dry working environments. The products / units must only be operated in compliance with the specifications stated in the Technical Data sheet.



Any use which deviates from that which was originally intended is regarded as improper use. Precitec shall not be liable for any damage caused by the improper use of the unit.

1.2 Obligations of operator and personnel

The operator of the system / machine is obliged to ensure that the personnel working at the machine

- are familiar with the basic safety at work and accident prevention regulations and been instructed on how to operate the machine.
- have read and understood the safety notes contained in these operating instructions and have confirmed this with their signature.

Personnel must be instructed according to the regulations and safety notes and informed of potential hazardous situations.

Precitec shall not be liable for any damage caused by not complying with or having insufficient knowledge about the information contained in the operating instructions.

Manufacturer's and supplier's regulations must be observed. The prescribed protective equipment must be used.

1.3 Safety measures



If it has been decided that safe operation is no longer possible, the product/ device or machine must be switched off and protected against unintended use.

1.4 Meaning of symbols and notes

In these operating instructions, the following designations and symbols are used to indicate hazardous situations and for notes.



Warning!

This symbol indicates an imminent or potential danger to the life and health of individuals. Not observing these notes may result in severe effects on health or life-threatening injuries.



Caution!

This symbol indicates a potentially hazardous situation. Not observing these notes may result in personal injury or damage to equipment.



Attention - Clean workplace!

indicates that any work on the product or any fitting or maintenance work must only be carried out in a clean workplace as dust and firmly adhering dirt can damage or destroy the components.



Attention!

Do not touch - indicates that touching the contact surfaces or optics can result in damage or destruction of components.



Important: Information the user must observe or know to avoid process disruptions or malfunctions when using the product.



Tip: Gives the user additional information needed to achieve the objective directly and without problems.

1.5 Risk of injury from laser radiation

The laser head does not emit any laser radiation. However, laser radiation is guided through the laser head. The machine must be switched off when carrying out any installation or maintenance work.



Caution — Laser beam!

During commissioning the machine may operate in **laser class 4**:

- Avoid radiation to eyes or skin caused by direct or scattered radiation.
- Do not look directly at the laser beam even using optical instruments.
- Use laser goggles complying with DIN EN 207 and BGV B2.

If it has been decided that safe operation is no longer possible, the product / unit or machine must be switched off. The unit or the machine must be protected against unintended use.

2 Safety notes for optics material

2.1 Optical components made from zinc selenide (ZnSe)



Optical components for CO₂ lasers are made from zinc selenide, a yellowish material.

2.1.1 Damaged optical components made from zinc selenide (ZnSe)



Warning — Risk of injury from toxic substances!

If the lens or protective window is destroyed or damaged, toxic dust containing selenide compounds can be emitted.

- Toxic by inhalation.
- Dust may be irritating to respiratory tract, skin and eyes.
- Call a doctor immediately in the event of accidents or illness.
- When using do not eat, drink or smoke.

2.1.2 First Aid measures



First Aid measures when contact with zinc selenide occurs:

- When inhaled, remove victim to fresh air, wash out mouth with water. Call a doctor.
- When skin contact occurs, wash off thoroughly with water and soap immediately. Consult a doctor if irritation persists.
- When eye contact occurs, wash out thoroughly with water immediately for at least 15 minutes. Call a doctor.

2.1.3 Action to be taken following an accident



Instructions for cleaning and disposal:

- Prevent formation of dust clouds.
- Do not breathe in dust. Wear suitable respiratory equipment.
- Wear safety glasses.
- Wear rubber gloves or plastic gloves.
- Wear suitable protective clothing.
- Prevent dispersion. Do not allow to enter sewerage system.
- Collect spilled material in sealable containers, mark containers and dispose off in accordance with local legislation.

2.2 Optical components with coatings containing thorium



Optical components for CO₂ lasers feature high-quality infrared anti-reflection coatings containing very small amounts of radioactive thorium. The thorium layer is sandwiched between other layers to produce a closed radioactive source.

If the coating is damaged, the amount of thorium released (even under unfavourable circumstances) does not result in a radiation exposure above the limits defined in the Radiation Protection Regulation.

During normal handling or cleaning of the optics, there is no risk of injury from radioactive radiation.

2.2.1 Damaged coating



Warning — Risk of injury from radioactive substances!

Damaged, scratched coatings present very little risk. However, very small amounts of thorium can be released

which are dangerous to health if inhaled or ingested. Despite low radioactive activity we recommend that you:

- wear a protective mask or respiratory equipment to prevent material inhalation.
- wash your hands thoroughly after contact with scratched coatings.
- remove loose material from the scratched area with a clean, soft cotton cloth well dampened with acetone.
- dispose of used cloths, gloves and masks in a sealed container.

2.2.2 Broken optical components



Warning — Risk of injury from radioactive substances!

Broken lenses only release very small amounts of thorium.

Broken components can cause skin injuries. To prevent ingress of thorium through open wounds, any wounds (or skin lesions) must be cleaned and dressed before continuing any clear up operation.

- Wear a protective mask or respiratory equipment.
- Wear rubber gloves or plastic gloves.
- Wear protective paper clothing.
- Avoid the production of airborne dust when sweeping up smaller fragments.
- Dispose of broken fragments, brush, dustpan, used cloths, gloves and masks in a sealed container.



The Radiation Protection Regulation contains the legal provisions for disposal.

3 Safety notes for cleaning agents



Caution – Irritating cleaning agents!

Always wear protective glasses. When cleaning the optics with cleaning agents there is a risk of eye damage from splashes.

Should contact with the eyes occur rinse immediately with copious amounts of water for at least 15 minutes. Rinse thoroughly by spreading the eyelids open. Then seek medical advice.



Attention – Wear gloves!

Only use chemical-free, powder-free gloves or finger cots.



Attention – Ventilation!

When using cleaning agents, make sure that the workplace is sufficiently ventilated!



Attention – Methanol!

Methanol is toxic. Contact with the eyes may lead to permanent blindness, therefore we no longer recommend its use.!



Precitec recommends:

Use **ethanol**, **acetone** or **propan-2-ol** for cleaning.

3.1 Ethanol (denaturated alcohol, min. 99.5%)



Caution – highly flammable!

Forms a highly flammable air-vapour mixture.

3.2 Acetone or propan-2-ol (isopropanol)



Caution – highly flammable!

Forms a highly flammable air-vapour mixture.



Caution – irritating!

Contact causes eye and mucous membrane irritation.



Attention – Propan-2-ol!

Do **not** use propan-2-ol for aluminium coatings and substrates.

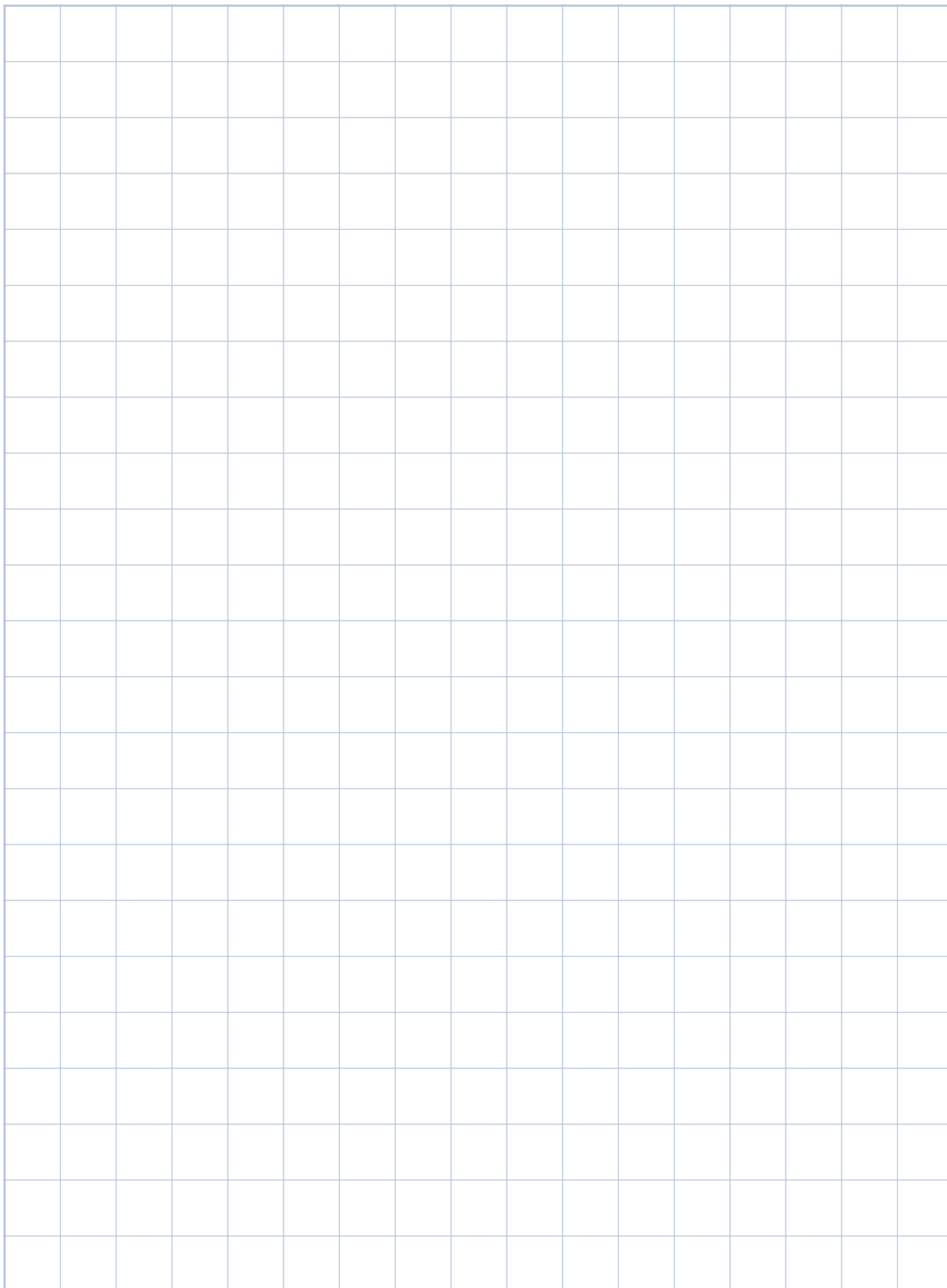

4 System description

4.1 Optical components - Function and principle

4.1.1 Beam path in the laser head



In solid-state, diode and disk lasers the laser beam is coupled into the laser head using a laser fibre. Adjustable optical components in the laser head align the laser beam in such a way that maximum power is achieved at the required focal point.

Interactive 3D graphics

[Click to start](#)



Abb. 4-1 Beam path in the laser head

- | | |
|--------------------------------|----------------------------------|
| 1 Fibre socket | 5 Collimated laser beam |
| 2 Fibre plug | 6 Focusing lens |
| 3 Laser beam exiting the fibre | 7 Protective window in cartridge |
| 4 Collimator | 8 Focus |

4.1.2 Laser fibre and fibre socket

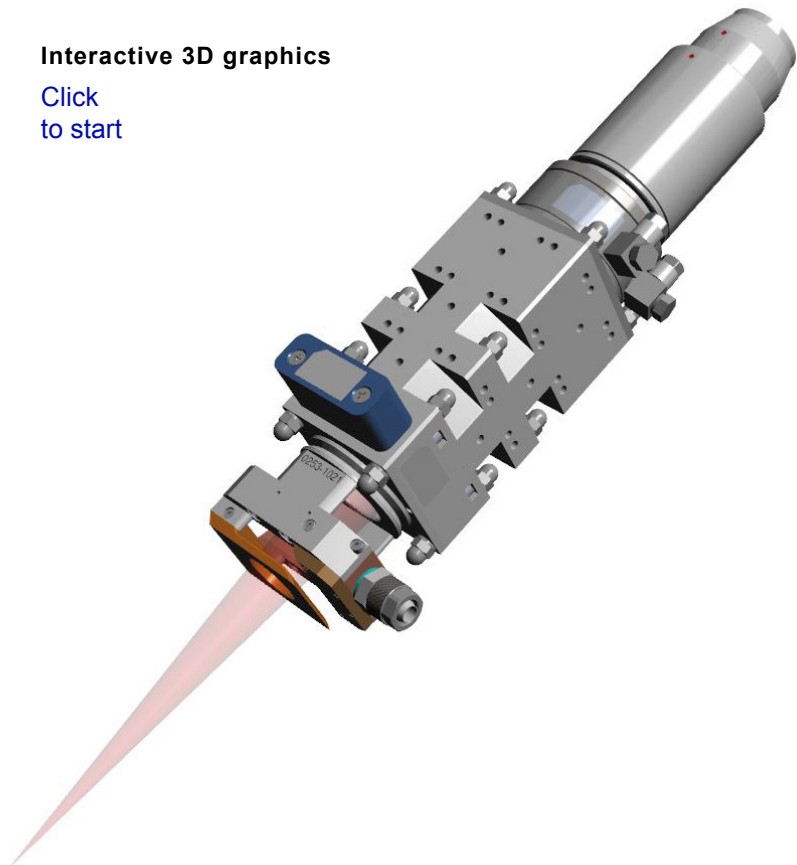
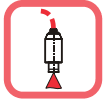

The laser fibre transmits the laser beam from the laser generator to the laser head - over several metres and almost loss-free. The laser beam exits the front end of the fibre plug as a divergent beam and is then coupled into the laser head's optics.



Abb. 4-2 Fibre plug systems

- | | |
|------------------------------------|-------------------------------------|
| 1 Q5 | 3 RQB |
| 2 QD with cooling water connection | 4 QBH with cooling water connection |

Typically, the light-guiding fibre core has a diameter of some to several hundred μm . The coupled laser power is several kW (depending on the application). Cooling is optional. The connection systems are specific to the machine manufacturer. Multiple jackets protect the fibre which includes sensors preventing the laser beam from exiting in an uncontrolled manner should the fibre break.

4.1.3 Collimator

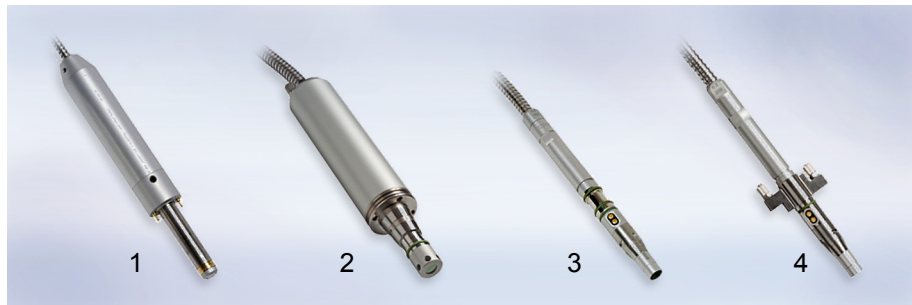

The collimator is the first optical component mounted in the laser head's beam path. It aligns the divergent beam exiting the laser fibre to form a parallel beam.



Abb. 4-3 Collimators with different focal lengths

Because of the laser beam's high power, the collimator or fibre plug must be integrated into the cooling water circuit and cooled.

4.1.4 Lens



The lens focuses the laser beam with a defined focal length f on the focal point at processing level. Depending on the application and system, single or multiple lenses (framed or not framed) are used.



Abb. 4-4 Lenses

The lens is installed either in the laser head or in an exchangeable cartridge. This depends on the system. The lens is cooled with cooling water (indirect cooling by conveying water around the lens holder) or cutting gas (direct cooling by conveying gas around the lens).

Lens quality and purity as well as precise lens adjustment are of paramount importance for good process results and a long service life.

4.1.5 Protective window

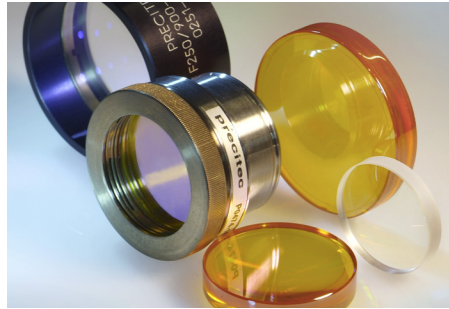

The protective window prevents spatter produced during the cutting or welding process from contaminating and damaging the high-quality lens. It is cheap and can be replaced quickly with the manufacturing process being interrupted for a short time only.



Abb. 4-5 Protective windows

Depending on the system, the protective window is installed either in the sensor insert or in an exchangeable cartridge and cooled by cutting gas (that is conveyed around it).

4.2 Optics material

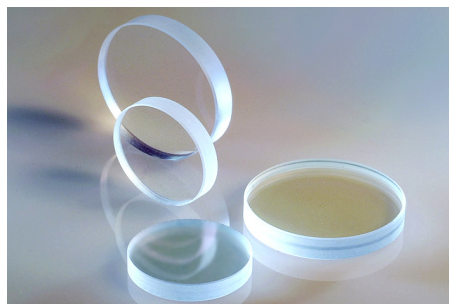

Laser systems have different light wavelengths. Lenses and windows must therefore be made from special material.

Typical CO₂ laser machines feature optical components made from zinc selenide (ZnSe).

In YAG laser machines quartz optics are installed.



Abb. 4-6 Optics material

1 ZnSe lenses for CO₂ laser machines 2 Quartz lenses for YAG laser machines

4.3 Optics coating

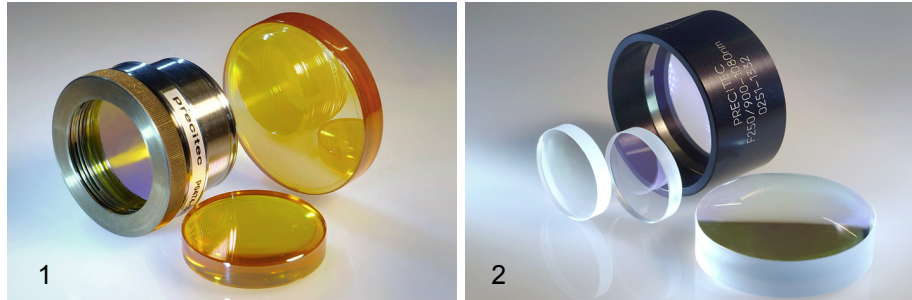

Coatings (e.g. anti-reflection coatings) on the surface of optical components have specific properties and often consist of several layers, meeting the requirements of different light wavelengths.

The coatings are very sensitive and must be handled with care.



Abb. 4-7 Optics coating



Attention — Clean metal coatings with compressed air only!

Some optical components such as mirrors have a metal coating.

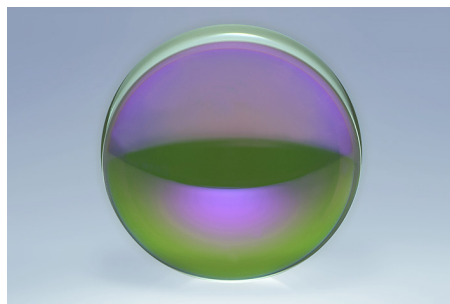
The coatings are very soft and may only be cleaned with compressed air. Wet lens paper can cause scratches, even when removed carefully.

4.4 Optic basics

4.4.1 Aspect ratio / focus diameter

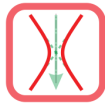

The parameters for the connected laser fibre and built-in beam guidance optics determine the aspect ratio and focus diameter.

The smaller the focus diameter, the higher the power density and possible process accuracy will be.



Abb. 4-8 Example of a laser head configuration

d_{LF} Laser fibre diameter

F_F Focusing lens focal length

F_C Collimator lens focal length

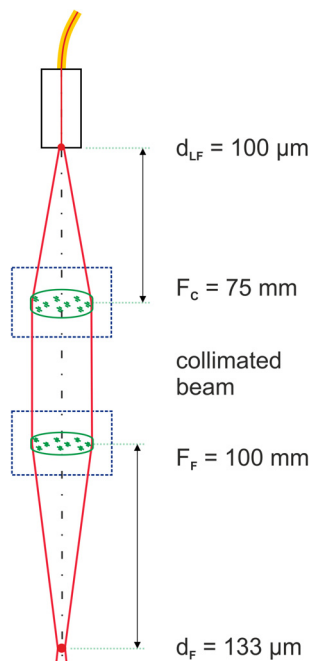
d_F Focus diameter (beam waist)

- **Calculating the aspect ratio (V):**

$$V = F_F : F_C$$

Sample configuration values:

$$100 \text{ mm} : 75 \text{ mm} = 1.33$$

- **Calculating the focus diameter (d_F):**

$$d_F = F_F : F_C \times d_{LF}$$

Sample configuration values:

$$100 \text{ mm} : 75 \text{ mm} \times 100 \text{ µm} = 133 \text{ µm}$$

or:

$$d_F = V \times d_{LF}$$

$$1.33 \times 100 \text{ µm} = 133 \text{ µm}$$

4.4.2 Rayleigh length



The laser beam caustic is characterised by the beam waist and Rayleigh length.

In the area where the Rayleigh length is doubled (also called "depth of focus") the laser beam is suitable for cutting.

The Rayleigh length Z_R is the distance along the optical axis from the beam waist (W_0) to the place where the area of the cross section of the laser beam is doubled.

At the Rayleigh length point the radial size is larger by a factor of $\sqrt{2}$.



Abb. 4-9 Rayleigh length calculation based on divergence angle

Θ_0 Divergence angle (rad)	W_L Focusing lens radius
Z_R Rayleigh length	F_F Focusing lens focal length
W_0 Beam waist radius (focus)	b Depth of focus

• **Calculating the divergence angle (Θ_0):**

$$\Theta_0 = W_L : F_F$$

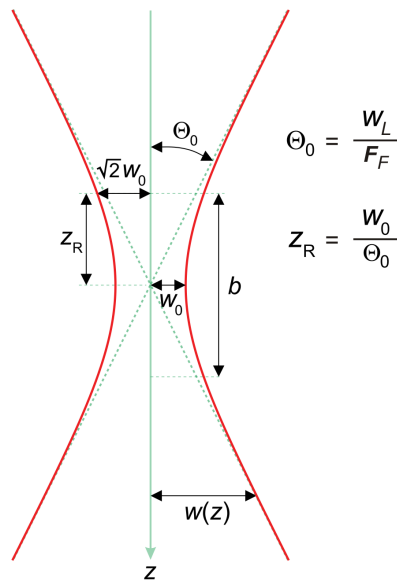
Sample configuration values:

$$15 \text{ mm} : 100 \text{ mm} = \mathbf{0.15 \text{ rad}}$$

• **Calculating the Rayleigh length (Z_R):**

$$Z_R = W_0 : \Theta_0$$

Sample configuration values:

$$67 \mu\text{m} : 0.15 = 447 \mu\text{m} = \mathbf{0.45 \text{ mm}}$$

• **Calculating the depth of focus (b):**

$$b = Z_R \times 2$$

$$0.45 \text{ mm} \times 2 = \mathbf{0.90 \text{ mm}}$$



The smaller the focus diameter, the higher the power density will be. This means, however, that the Rayleigh length is very short and that the process is more sensitive to standoff distance and path variations.

4.4.3 Beam parameter product

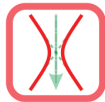

The beam parameter product (BPP) describes the beam quality and thus the focusing accuracy of the laser beam.

The smaller the beam parameter product, the higher the beam quality.

The beam parameter product is proportional to the product obtained by multiplying the beam waist radius (W_0) by the divergence angle (Θ_0).

- **Calculating the beam parameter product (BPP):**

$$\text{BPP} = W_0 \times \Theta_0$$

Result for the sample configuration ($W_0 = 67 \mu\text{m} = 0.067 \text{ mm}$), ($\Theta_0 = 0,15 \text{ rad} = 150 \text{ mrad}$):

$$0.067 \text{ mm} \times 150 \text{ mrad} = \mathbf{10.0 \text{ mm mrad}}$$



All sample calculations are valid for laser beams with an ideal Gaussian profile. Actual laser beam profiles, however, differ from the Gaussian profile to a greater or lesser extent.

For that reason, the sample calculations only deliver approximate results.

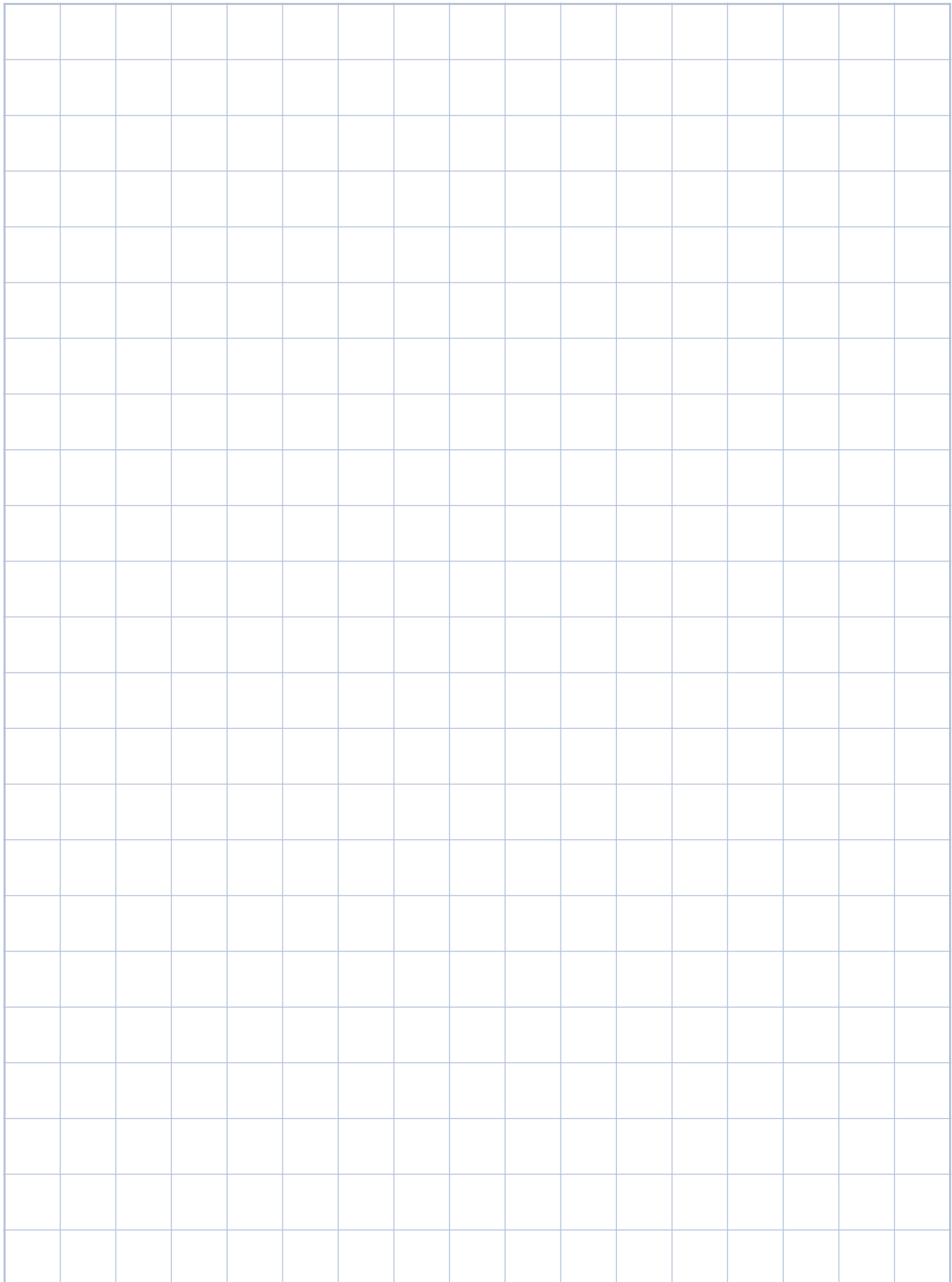

5 Contaminated or defective optics

5.1 Aids for finding the cause



Important: Assessing the contamination level correctly requires relevant experience and should only be carried out by trained personnel.

Contamination caused by cutting or welding spatter, dirt particles, cleaning agent residue, fingerprints, unclean process gases, etc. has a very great impact on the damage threshold of optical components, specifically protective windows and lenses.

5.1.1 Contaminated protective window



Protective windows are mainly contaminated by spatter and fumes from the cutting and welding process. Depending on the contamination level, they can be cleaned and used again.



Abb. 5-1 Contaminated protective windows

1 Slightly contaminated protective window

2 Heavily contaminated protective window

If the protective window can no longer be cleaned, it must be replaced.

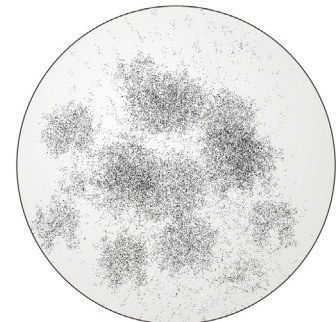
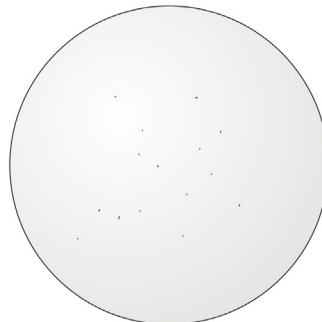

Caution: Dirty protective windows must never be used and inserted again. Any dirt that comes off the glass surface would cause burn marks on the lens or otherwise damage the lens and the sensor insert.

5.1.2 Contaminated lens



When the lens is dirty, you must first check whether the upper side or underside is contaminated. This will tell you the cause of the contamination.



Abb. 5-2 Contaminated lenses

1 Slightly contaminated lens

2 Heavily contaminated lens

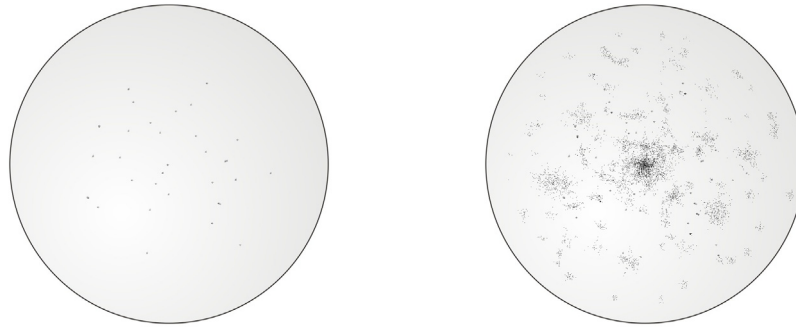

Contamination will result in a scattered laser beam, bad cutting quality and reduce the lens service life.

Causes of contaminated underside (side pointing to the workpiece):

- Wrong input pressure (too low), specifically when cutting with nitrogen
- Distance to workpiece surface is too small
- Lens is not focused / wrong cutting speed
- Workpiece quality, mainly rust
- Auxiliary gas pressure too low
- Thermal lens curvature caused by material stress, scratches on lens or surface, metal spatter, etc.

Causes of contaminated upper side (side pointing to the collimator):

- Beam delivery system not sealed (holes in the compensators). Small particles get into the beam delivery system and on the upper side of the lens which causes an uneven heat distribution.
- Contamination caused by oil / liquids (clogged filters and air separators)

5.1.3 Damaged lens - Part 1



The lens damage pattern can be an indicator of typical causes.

See the examples and descriptions below.



Abb. 5-3 Damaged lenses

1 Star-shaped cracks

2 Broken lens

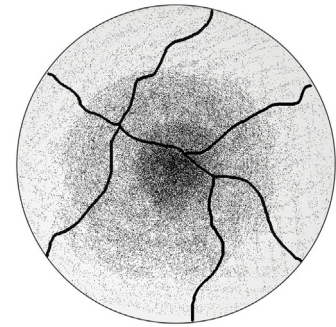
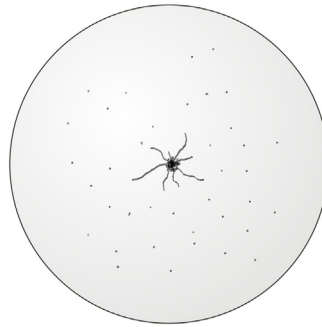

Uneven heat distribution in focusing optics often causes star-shaped cracks or lens breakage.

Causes (1):

- Interaction between laser beam and metal spatter
- Irregular beam shape
- Insufficient lens cooling

Causes (2):

- Oil residue on the lens upper side absorbs a large amount of laser power and leads to irregular heat distribution (hot spots) which causes the lens to explode.
- Contaminated gas (e.g. from the compressor feeding compressed air to the beam system)

This error goes from the top to the bottom and creates a hole that opens up from the lens centre. Brown residue or local, irregular discolouration on the upper side indicates that oil products are present on the lens surface. The optical error is caused by contamination in the beam delivery system/purging air system.

5.1.4 Damaged lens - Part 2



More examples and descriptions of possible causes.



Abb. 5-4 Damaged lenses

3 Beam mode error

4 Beam alignment error

Causes (3):

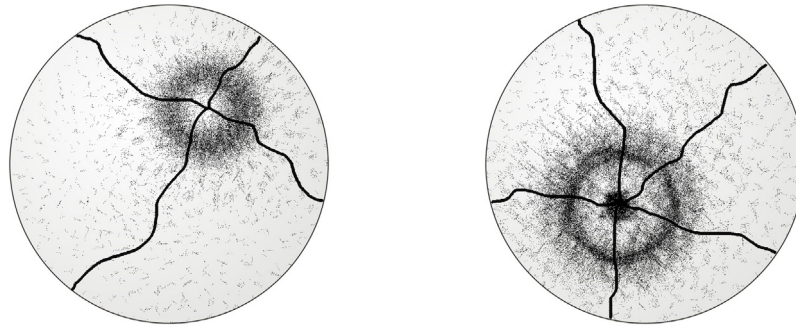
- Deformed mode
- Wrong mirror alignment
- Laser generator cooling defect

This results in a large cracks running over the edges and a burn mark which is not centred in one area of the lens upper side.

This type of burn mark is typical of a beam mode error. A deformed mode can create a very high amount of energy which concentrates in a small spot on the lens and causes the lens to explode.

In most cases a beam mode error is caused by a wrongly aligned mirror or defect in the beam delivery cooling system.

Causes (4):

- Beam not centred
- Beam is not parallel with one or more axes and hits the lens holder.

5.1.5 Damaged lens - Part 3



More examples and descriptions of possible causes.



Abb. 5-5 Damaged lenses

5 Broken edges

6 Damaged coating

Causes (5):

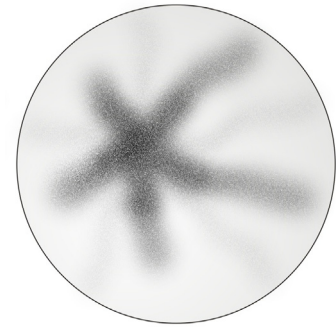
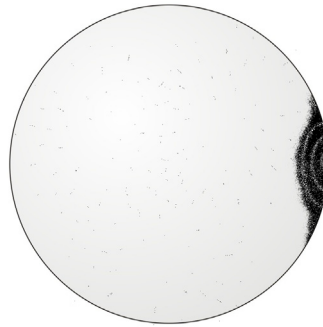
- Metal burr on processed surfaces
- Contamination (metal particles) in the holder

A defective lens holder exerts high pressure on the optics' edges, resulting in broken edges or scratches along the perimeter.

Causes (6):

- Improper cleaning (residue might still be present)
- Wrong cleaning agents, bad quality
- Too aggressive cleaning agents (cause scratches)
- Bad lens quality

5.1.6 Contaminated fibre end



Because of the small diameter of the light-transmitting fibre core and the high performance of the laser beam, very small particles can quickly burn in the fibre end.



Abb. 5-6 Contaminated fibre end



The contamination level of the fibre end can only be assessed using a microscope with a high enlargement factor.

Contamination not visible with the human eye can already have a very high impact on laser beam quality, causing a strong focus shift for instance and having a negative effect on the process.

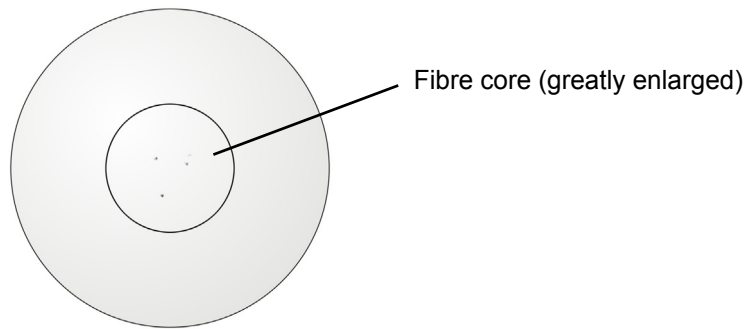
Causes:

- Plug removed from the fibre socket in an unclean environment
- Metal abrasion when inserting the plug into the fibre socket or during removal
- Improper cleaning (residue might still be present)
- Wrong cleaning agents, bad quality
- Too aggressive cleaning agents (cause scratches)

5.1.7 Contaminated collimator



The collimator is not directly affected by the cutting or welding process. This means that contamination does not occur often and the degree of contamination is smaller than with lenses and protective windows.



If the collimators are damaged, the damage patterns are similar to the ones described for lenses.

Causes:

- Dirt getting into the unit through an open fibre socket (no protective film) during maintenance work
- Plug removed from the fibre socket in an unclean environment
- Metal abrasion when inserting the plug into the fibre socket or during removal
- Improper cleaning (residue might still be present)
- Wrong cleaning agents, bad quality
- Too aggressive cleaning agents (cause scratches)



Attention — Removal, installation, cleaning!

Depending on the laser head system, only specially trained personnel are allowed to remove, install and clean the collimator.

Talk to the laser machine operator before removing the collimator!

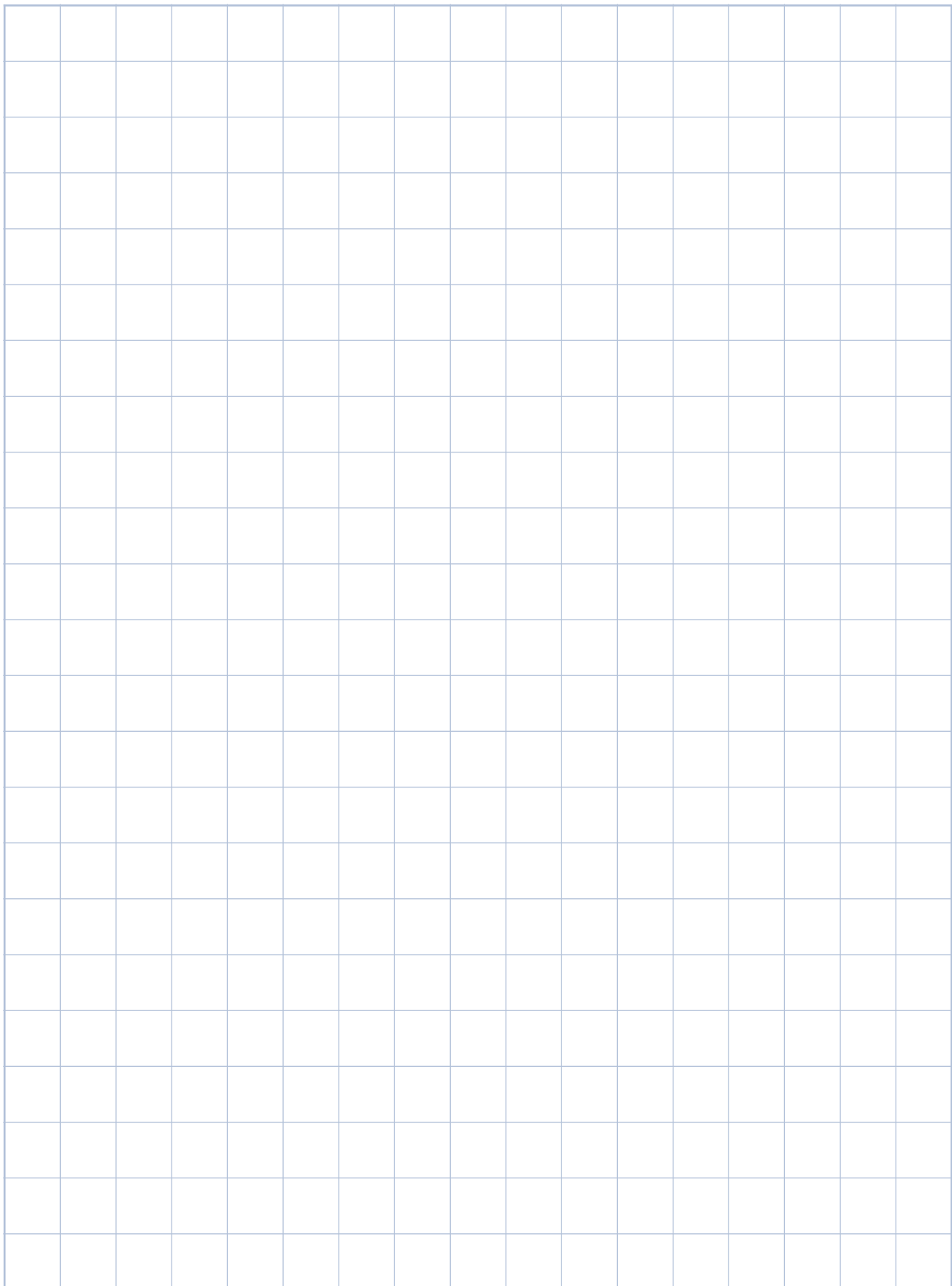

6 Equipment

6.1 Working environment and auxiliary material



A clean working environment is of paramount importance when replacing and cleaning optical components!

We recommend that you carry out any work on the optical components in a Flow Box to achieve cleanroom conditions.

6.1.1 Flow Box



Abb. 6-1 Flow Box principle:

- | | |
|---------------------|--------------------|
| 1 Air supply | 4 Main filter |
| 2 Pre-filter | 5 Laminar air flow |
| 3 Adjustable blower | 6 Worktop |

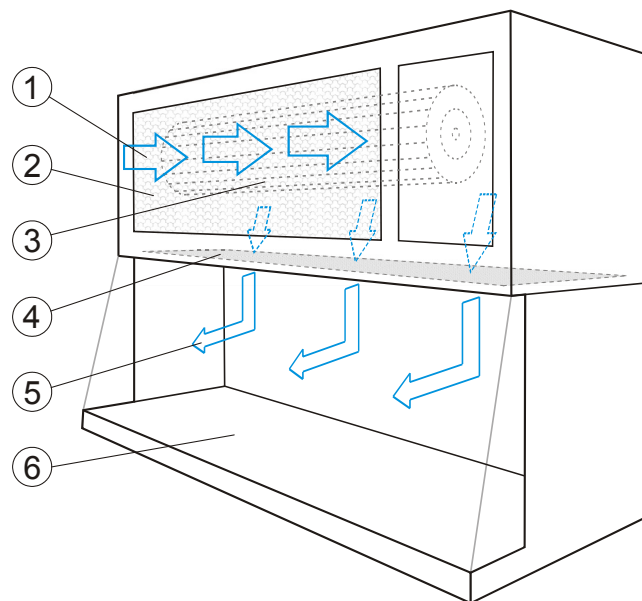

Attention — Cleanroom workplace (Flow Box)!

Any fitting and conversion work, especially on the laser head's beam path optics (collimating and focusing optics) must only be carried out in a cleanroom workplace.

Only open up the laser head's beam path for a short time to protect it from dust and dirt.



Please locate a particularly clean room if no cleanroom workplace is available. Use a worktop that is highly dust-free and resistant to chemicals (e.g. formica, glas) and clean it thoroughly before carrying out any cleaning work.

6.1.2 Gloves, protective glasses, pad



Attention – Sensitive optics!

Dust, fingerprints and firmly adhering dirt can lead to burn marks on the optics or destroy them, even after short operating times.

Only touch the non-sensitive parts of the optical components or hold them by the frame.



Wear protective glasses to protect your eyes against splashes from cleaning agents.



Wear gloves or finger cots with the following properties:

- resistant to solvents
- powder-free



Use soft, lint-free, chemical-free cloths as pads for the optics to prevent scratching the optical components and their coating.



Abb. 6-2 Gloves, protective glasses, pads

6.1.3 Illumination, background

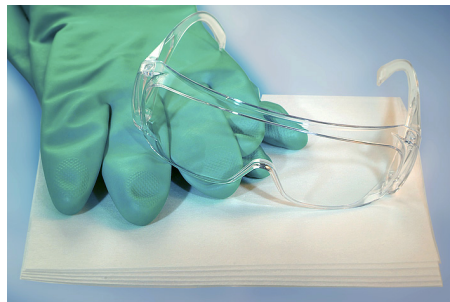

Visual checks

Optical components (e.g. lens or protective window) can be checked using either a transmissive or grazing light source.



Abb. 6-3 Checks using a transmissive light source

- 1 Eye of the person performing the check 3 Light source
2 Optical component to be checked

Checks using a transmissive light source:

- Hold the optical component against the light area of a fluorescent light.
- Look at the optical component by holding it in front of the bright background and check for burn marks caused by spatter.

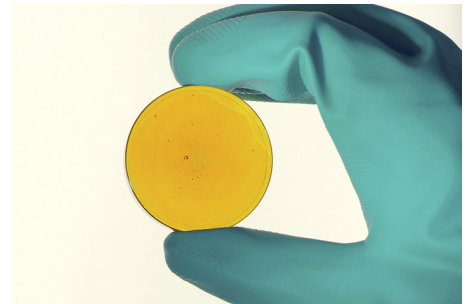
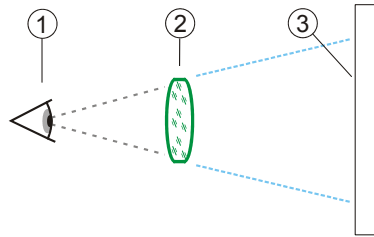

Abb. 6-4 Checks using a grazing light source

Checks using a grazing light source:

- Align the light and optical component in such a way that the light beam penetrates the optical component at an angle and that you are not dazzled.
- Look at the optical component by holding it in front of a dark background and check for scratches or contamination.

- 1 Eye of the person performing the check 3 Light source
2 Optical component to be checked 4 Dark background

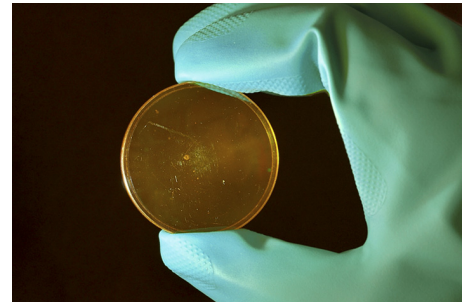
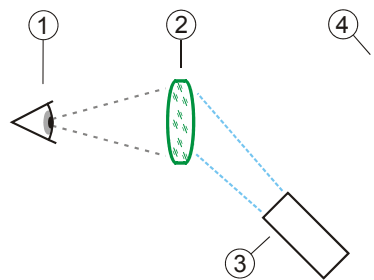
6.1.4 Compressed air



Abb. 6-5 Compressed air



Attention — Sensitive optics surface!

Compressed air from can **must not include any oil or residue!**

Do not use standard industrial compressed air! Oil residues and dust cause burn marks.

DO NOT blow with your mouth! Saliva droplets cause burn marks.

6.1.5 Cleaning pads (swabs)



Abb. 6-6 Cleaning pads (swabs)



Attention — Use dampened cleaning pads only!

Only use cleaning pads dampened with the cleaning agent!

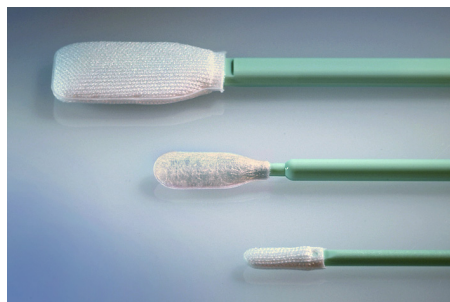
Only use solvent-resistant cleaning pads designed for use in a cleanroom workplace.

Always hold the cleaning pads by the handle.

Do not touch the head with your fingers.

Always keep new cleaning pads in a dust-free case.

6.1.6 Cleaning agents



Abb. 6-7 Cleaning agents



Precitec recommends the following cleaning agents:

- Ethanol (denaturated alcohol) - content >99.5%
- Acetone
- Propan-2-ol (Isopropanol)

6.1.7 Protective film, storage box



Abb. 6-8 Protective film, storage box



Attention — Contamination caused by open beam path!

Always cover beam path openings on the laser head and optical component frames with protective film to prevent dirt getting in.

Storage boxes for optical components must be spotlessly clean and dust-free. Loosely wrap the optical elements in paper designed for the purpose. Do not place them into the storage box unpacked.

6.1.8 Disposing of cleaning material



Attention — Contaminated cleaning material!

Throw away dirty cleaning material. Do not touch the optics surface with used cleaning pads.

Only use washing solutions once. (Risk of optics getting contaminated again.)

6.1.9 Precitec Service Case

Precitec offers a service case with useful accessories for basic cleaning.



Abb. 6-9 Precitec Service Case

- | | | | |
|---|---------------------------------------|---|---------------------------------|
| 1 | Narrow mouth bottle (100 ml) | 3 | Cleaning paper, protective film |
| 2 | Cleaning swabs (large, medium, small) | 4 | Pasteur pipette |

Cleaning agents and accessories not included in the package:

- Canned air (cleaned, ionised compressed air)
- Microfibre cloths for the lens
- Gloves
- Protective glasses

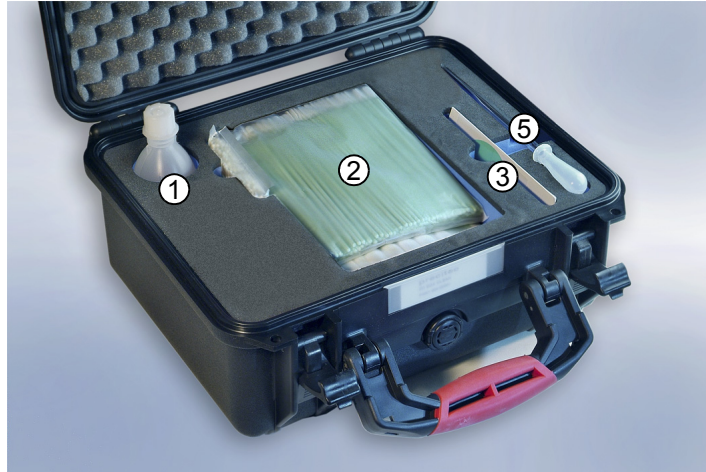
6.1.10 Unsuitable cleaning agents and auxiliary material

Precitec advises against using the following cleaning agents and auxiliary material:



Attention – Do not use cleaning wipes for spectacles!

Residue from anti-fog agents can damage lens and mirror coating.



Attention – Unsuitable cleaning agents!

Do not use camera or contact lens cleaners! These could contain water and damage the lens and the mirror coating.

7 Cleaning the optics

7.1 Recommendations



Always check the optics for contamination before cleaning.
The optics should only be cleaned if necessary.
Unnecessary or too frequent cleaning can damage the sensitive optics surfaces, causing premature wear.



Determine the test and cleaning intervals. These depend on your manufacturing process.
To achieve the maximum benefit from the laser's optimum power and beam quality, always adhere to these intervals.
Shorter intervals are necessary with processes that create particularly high smoke and grime emissions such as processing wood or rubber.



Follow the instructions described below and check the optics' condition after each step.

7.1.1 Step 1: Removing loose dirt

Completely remove loose particles on the surface with a compressed air jet.



Attention – Do not touch the surfaces!

- Important – Spray compressed air onto the optics from a distance of at least 15 cm to avoid condensation forming on the optics.
- Hold the bottle upright and do not shake it!
- And watch for small glass particles on the edge of the substrates!



Abb. 7-1 Cleaning with compressed air



Important!

After every cleaning process check the optics for dirt with another visual check. Continue with step 2 if necessary.

7.1.2 Step 2: Removing firmly adhering dirt

Remove any dirt with a cleaning pad (swab).



Attention – Wet cleaning only!

Cleaning swabs must always be dampened with the cleaning agent. Dry cleaning swabs damage the coating and optics surface.



Abb. 7-2 Cleaning with swabs

1. **Soak the cleaning swab with liquid (approx. 3 - 4 drops).**
Avoid pressing too hard when cleaning.
2. **Don't rub in any dirt – just dab it off.**
3. **Use circular cleaning movements from the centre of the optical surface outwards.**

The liquid should evaporate directly behind the swab, leaving no residue. Hold the swab only by the handle or shaft.



Important!

After every cleaning process check the optics for dirt with another visual check. Repeat cleaning if necessary.



Attention – Cleaning not successful!

If the optics component cannot be cleaned with a swab, it must be replaced. Using contaminated optical components can destroy these components very quickly. Other components of the laser head could also be damaged!

8 Installing and removing optical components

8.1 Protective window



For more detailed information about removal and installation, please refer to the relevant operating instructions for the laser head.



Abb. 8-1 Replacing the protective window

- | | |
|---------------------|-------|
| 1 Protective window | 3 Nut |
| 2 Sensor insert | |

■ Removing the protective window

1. Remove the sensor insert and cover the opening on the laser head with protective film.
2. Take the sensor insert in your hand (rotated by 180°). The protective window frame must be facing downwards.
3. Put the auxiliary tool on the protective window frame and remove it by turning the tool anticlockwise.
4. Carefully remove the protective window and the O-ring from the protective window frame. Mind the O-ring while doing this. You will need it again.

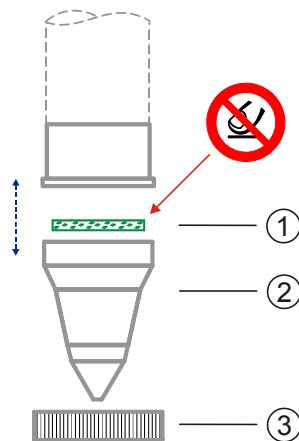

Important: Dirty protective windows must never be turned and inserted again. Any dirt would cause burn marks on the lens and otherwise damage the lens and the sensor insert.



Clean the protective window as described in Chapter 7 "Cleaning the optics".

If the protective window can no longer be cleaned or if it is damaged, it must be replaced.

■ Installing the protective window:

1. Put the auxiliary tool on a level surface with the pins facing upwards.
2. Lift up the protective window frame on the pins of the auxiliary tool and insert the protective window into the frame.
3. Push the O-ring on to the auxiliary tool.
4. Put the auxiliary tool with the O-ring on to the protective window.
5. Lightly press the fitting tool (together with the control ring (aluminium washer)) on to the protective window, letting the O-ring with the control ring remain on the protective window.

**Caution – Fitting tool!**

Do not press the fitting tool too hard – otherwise the protective window could break.

6. Keep the control ring gently pressed on to the protective window frame and pull the auxiliary tool carefully away from the protective window.
7. Use the auxiliary tool to insert the protective window frame into the sensor insert and screw it in firmly (up to the mechanical stop).

**Attention – Pressure tightness!**

The protective window frame (which includes the protective window) helps to ensure the laser head's pressure tightness. If the protective window is not screwed in firmly enough, the following malfunctions can occur:

- The protective window has too much free play and the cutting gas pressure causes it to vibrate.
- The focal position is incorrect and this causes bad cutting results.

8. Insert the sensor insert and screw it on manually (hand-tight) using the nut.

8.2 Lens



For more detailed information about removal, installation and cleaning, please refer to the relevant operating instructions for the laser head.



Abb. 8-2 Replacing the lens

- | | |
|-----------------------|-------|
| 1 Lens in lens holder | 3 Nut |
| 2 Sensor insert | |

■ Lens removal – Preparations

1. Switch the cutting machine off and protect it against being switched on again.
2. Let the laser head cool down and clean with a damp cloth.

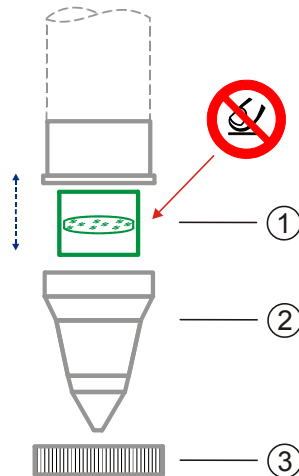
■ Removing the lens holder

3. Unscrew the nut and remove the sensor insert.
4. Unscrew and remove the lens holder using the auxiliary tool.



Clean the lens as described in Chapter 7 "Cleaning the optics".

If the lens can no longer be cleaned or if it is damaged, it must be replaced.

■ Installing the lens

1. Screw the lens holder into the laser head using the auxiliary tool. The zero mark must match the lower visible edge.

2. Insert the sensor insert completely into the laser head (with protective window and nozzle) before fastening the nut. Then fasten the nut hand-tight.



Attention — Laser beam position!

Check the focusing optics' centring and the focal position each time the lens holder is removed or fitted.

8.3 Removing and installing the laser fibre

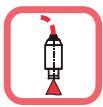

For more detailed information about removal, installation and cleaning, please refer to the relevant operating instructions for the laser head.



Attention — Removal, installation, cleaning!

Depending on the laser head system, only specially trained personnel is allowed to remove, install and clean the laser fibre connection.

Talk to the laser machine operator before removing the laser fibre connection!



Abb. 8-3 Laser fibre

- | | |
|---------------------------------------|----------------|
| 1 Linear drive in horizontal position | 3 Cover ring |
| 2 Fibre plug | 4 Fibre socket |

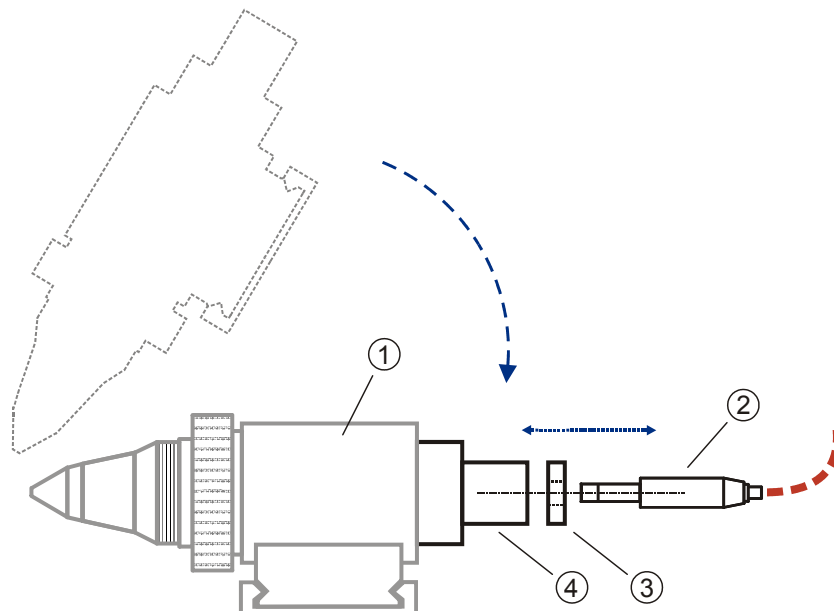

The cover ring prevents dust and dirt from getting into the fibre socket. The laser fibre must therefore only be removed from the laser head and installed into it in a horizontal position.

■ Removing the fibre plug

1. Move the laser head into a horizontal position.
2. Clean the fibre plug, cover ring and fibre socket with a damp cloth.
3. Carefully remove the fibre plug and the cover ring.
4. Cover the fibre socket with protective film and put the protective cap on the fibre plug.

■ Installing the fibre plug

1. Remove the protective film from the fibre socket and the protective cap from the fibre socket.
2. Put the cover ring on the fibre socket.
3. Carefully insert the fibre plug into the fibre socket.
4. Fix the fibre plug or lock the bayonet nut connector.



Attention: fibre to fibre coupling - excessive radiation and overheating!

Excessive radiation from the optics can cause the laser head to overheat. This effect can occur if part of the laser radiation couples into the fibre sheathing (cladding) when the fibre core diameter is small ($\leq 100 \mu\text{m}$), for instance.

So please make sure that the fibre and fibre coupling are exactly aligned with one another!

Please contact the coupler manufacturer if necessary.



Optimum sealing

Processes that create a lot dust may require special sealing at the connection between the fibre plug and fibre socket.

We recommend that you use flexible, silicone-free no-residue adhesive tape.

- **Firmly wind 3 to 4 layers of adhesive tape around the fibre plug and fibre socket.**

8.4 Removing and installing the collimator



For more detailed information about removal, installation and cleaning, please refer to the relevant operating instructions for the laser head.



Attention – Removal, installation, cleaning!

Depending on the laser head system, only specially trained personnel is allowed to remove, install and clean the collimator.

Talk to the laser machine operator before removing the collimator!

Precitec laser heads feature different types of collimator models:

- external collimators (depending on the linear drive used)
- internal collimators (depending on the linear drive used, FormCutter)
- integrated collimators (SolidCutter)

Removing the collimator



Abb. 8-4 Examples:
LD30C
External collimator



Collimator in linear drive
(thread fitting)

1 Fibre connection

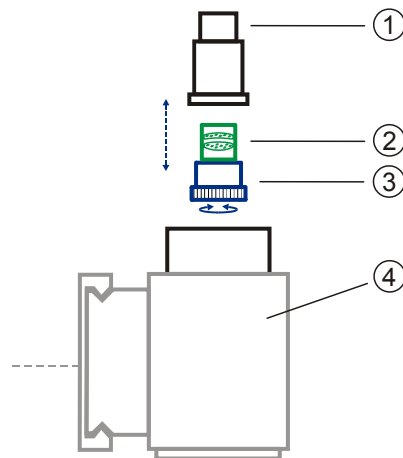
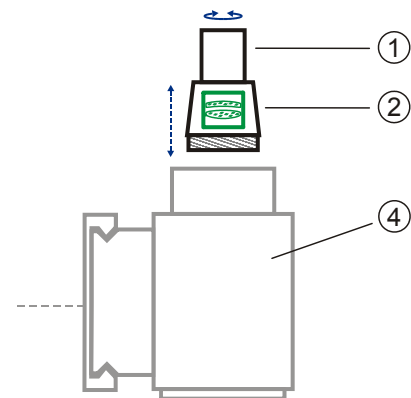
2 Collimator

3 Auxiliary tool

4 Linear drive



Attention – Media supply lines!

When carrying out any maintenance and repair work on the collimator, the media supply lines must be removed by disconnecting the connection couplings. The system must not be under pressure when doing this.

1. Remove the media supply lines from the collimator.
Make sure that dust and dirt cannot get into the collimator and laser head.
2. Unscrew and remove the fixing screws from the collimator.
3. Now put the collimator on a clean pad.



Cleaning the collimator

Only open up the processing head's beam path for a short time to protect it from dust and dirt.



Attention – Sensitive optics!

Blow any dirt off the collimator lens using clean compressed air.

Repeat until the lens surface is clean.

If the lens surface cannot be cleaned with clean compressed air or a damp cleaning pad, send the lens holder back to Precitec for cleaning.

Damaged lenses (and lens holders) must be replaced.

Installing the collimator

1. Insert the lens holder (with clean collimating lens) into the collimator. Mind the installation position / marking when doing this.
2. The threaded ring and the mark on the lens holder must point in the direction of the laser fibre end.
3. Secure the lens holder with the threaded ring hand-tight.
4. Connect the media supply lines to the relevant collimator connections.

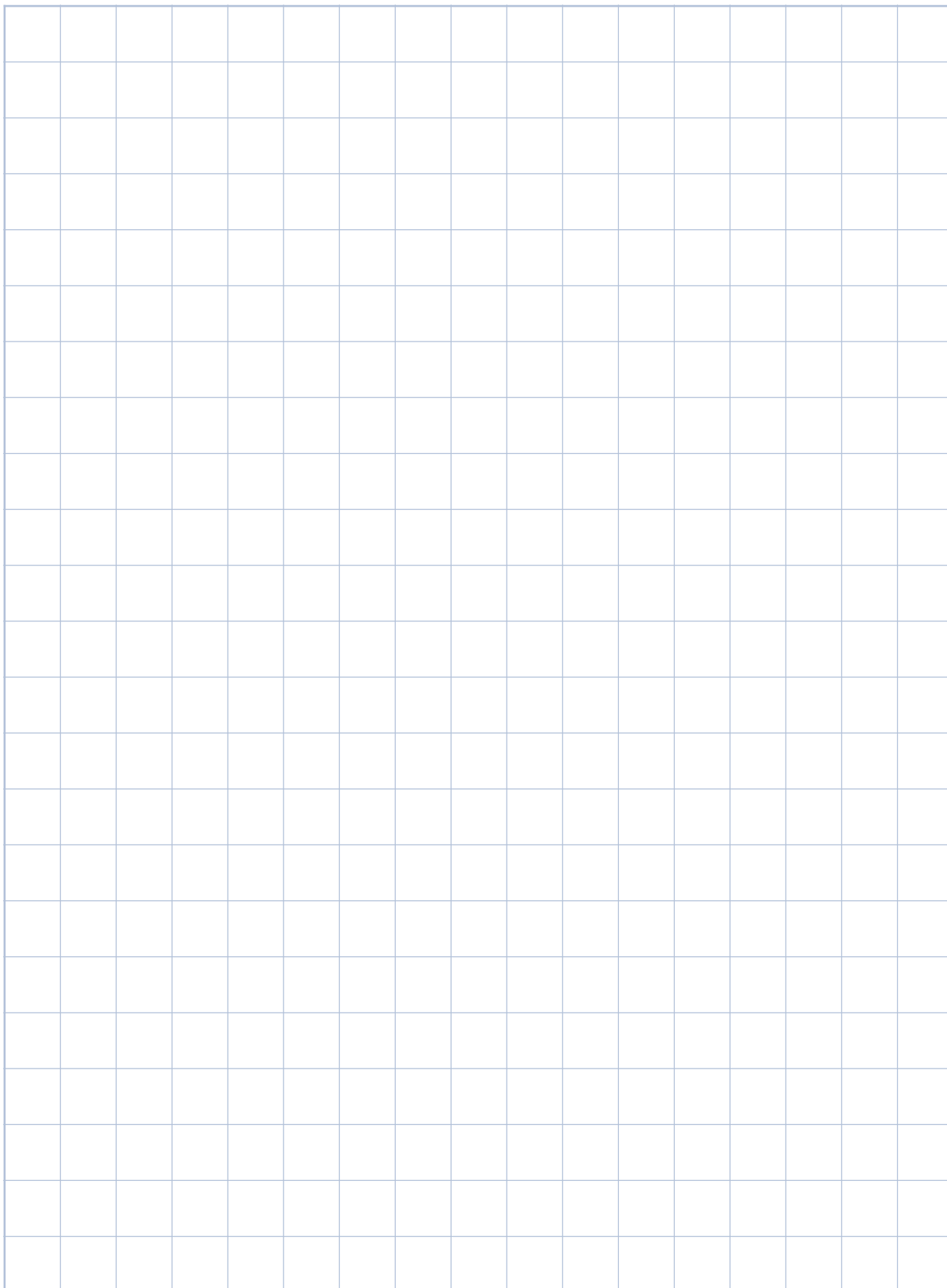

9 Appendix

9.1 Basic technical information

9.1.1 Conversion of Units

1.0 mm	= 0.03937"
25.4 mm	= 1.0"
1.0 kg	=2.20 lb (pounds)
1.0 bar	=0.1 MPa =14.50 psi (pounds/square inch) =0.99 atm (atmosphere)
1.0 l (litre)	= 1.06 qt (quarts US) = 0.88 qt (quarts Imp)
0.0284 l	= 1.0 fl oz (fluid ounce)

Tab. 9-1 Appendix: Units - Conversion table

9.1.2 Translation of technical terms

English	German	Français	Español
Laser gases			
argon	Argon	argon	argón
carbon dioxide	CO ₂ - Kohlendioxid	dioxyde de carbone	dióxido de carbono
compressed air	Druckluft	air comprimé	aire comprimido
cutting gas	Schneidgas	gaz de coupe	gas de corte
helium	Helium	hélium	helio
mixed gas	Mischgas	mélange gazeux	mezclas de gas
neon	Neon	néon	neón
nitrogen	Stickstoff	azote	nitrógeno
oxygen	Sauerstoff	oxygène	oxígeno
purging gas	Spülgas	gaz de purge	gas de purga
xenon	Xenon	xénon	xenón

English	German	English	German
General (alphabetical)			
3D cutting	3-D Schneiden	90° angle fitting	90°-Winkelanschluss
accessories	Zubehör	adjusting screw	Stellschraube
adjusting ring	Stellring	adjustment screw	Justierschraube
adjustment range	Verstellweg	analysing electronics	Auswerteelektronik
annular jet nozzle	Ringspaldüse	aperture size	Blendengröße

English	German	English	German
area	Bereich	automatic mode	Automatikbetrieb
auxiliary tool	Hilfswerkzeug		
back reflection	Rückreflektion	back reflection detector	Rückreflex-Detektor
bad parts	Schlechtteile	beam bender	Strahlumlenker
beam path	Strahlengang	beam quality	Strahlqualität
beam source	Strahlquelle	bracket	Winkel
burn mark	Einbrand	burr	Grat
centring mechanism	Zentriervorrichtung	centring range	Zentrierbereich
centring screw	Zentrierschraube	ceramic part	Keramikteil
coaxial gas supply	Koax-Gaszuführung	collimator	Kollimator
collision detection (device)	Kollisionserkennung	collision signal	Kollisionssignal
collision protection (device)	Kollisionsschutz	CO2 lasers	CO2-Laser
compressed air	Druckluft	connection adapter	Anschlussadapter
contamination	Verunreinigung	control cable	Steuerkabel
conversion	Umrüstung	cooling gas	Kühlgas
cooling plate	Kühlplatte	cooling water	Kühlwasser
cooling water connection	Kühlwasser-Anschluss	cutting gas	Schneidgas
cutting gas connection	Schneidgasanschluss	cutting gas pressure	Schneidgasdruck
cutting gas supply line	Schneidgaszuleitung	cutting head	Schneidkopf
degree of contamination	Verschmutzungsgrad	default setting	Voreinstellung
defective weld	fehlerhafte Schweißung	delay (ms)	Verzögerung (ms)
diameter	Durchmesser	diode laser	Dioden-Laser
distance sensor system	Abstandssensorik		
earth cable	Massekabel	earth connection	Erdungsanschluss
electrode cable	Elektrodenkabel	error	Fehler
extension	Verlängerung		
feed line	Zuleitung	fibre-coupled beam	fasergekoppelter Strahl
fibre laser	Faser-Laser	filter	Filter
flow rate	Durchflussmenge	focal length	Brennweite
focal position	Fokuslage	focusing lens	Fokussierlinse
gas connection	Gas-Anschluss	gas stream	Gasstrom
gas pressure	Gasdruck	graticule	Fadenkreuz
horizontal adjustment (device)	Horizontaljustierung		

English	German	English	German
laser beam axis	Laserstrahlachse	laser beam diameter	Laserstrahldurchmesser
laser beam path	Laserstrahlengang	laser beam power	Laserstrahlleistung
laser beam position	Laserstrahlage	laser fibre	Laserfaser
laser goggles	Laser-Schutzbrillen	laser pulse	Laserpuls
laser radiation on the edges	Laser-Randstrahlung	lens diameter	Linsendurchmesser
lens holder	Linsenhalter	lens position	Linsenposition
linear drive	Achse	linear Z drive	Z-Achse
line laser	Linien-Laser		
machine controller	Anlagesteuerung	maintenance	Wartung
maintenance intervals	Wartungszyklus	malfunction	Störung
manometer	Manometer	manual mode	manueller Betrieb
measurement	Messung	media connection	Medien-Anschluss
media supply lines	Medien-Zuleitungen	motor cable	Motorkabel
motor controller	Motorsteuerung		
Nd:YAG laser	Nd:YAG-Laser	no dew	nicht betauend
not condensing	nicht kondensierend	nozzle cooling system	Düsenkühlung
nozzle electrode	Düsenelektrode	nozzle opening	Düsenbohrung
nozzle standoff (Zn)	Arbeitsabstand (Zn)	nozzle standoff distance	Düsenabstand
O-ring	O-Ring	oil content	Ölgehalt
optical axis	optische Achse	outcoupling	Auskopplung
overpressure	Überdruck		
photographic paper	fotoempfindliches Papier	piercing sensor system	Einstechsensorik
pilot laser	Pilot-Laser	plug-in connector	Steckverbinder
pressure gas system	Druckgasanlage	pressure measuring connection	Druckmessanschluss
pressure load	Druckbelastbarkeit	protective cap	Schutzkappe
protective film	Schutzfolie	protection class	Schutzklasse
protective window	Schutzglas	protective window cartridge	Schutzglas-Schublade
protective window contamination	Schutzglasverschmutzung	pulse duration	Pulsdauer
pulse operation	Puls-Betrieb		
reference value	Referenzwert	replacement part	Ersatzteil
return pipe	Rücklauf	risk class	Gefahrenklasse
risk of vibration	Schwingungsgefahr		
robot arm	Roboterarm	robot path	Roboterbahn

English	German	English	German
sample	Detektionsmittel	sealing ring	Dichtring
section	Ausschnitt	sensor cable	Sensorkabel
sensor connection	Sensor-Anschluss	sensor insert	Sensoreinsatz
sensor socket	Sensorbuchse	setting screw	Verstellschraube
setting tool	Einstellwerkzeug	sheet metal	Blech
shielding gas	Schutzgas	shielding gas supply	Schutzgaszufuhr
solid-state laser	Festkörper-Laser	stainless steel	Edelstahl
teach-in process	Teach-In-Verfahren	teach tip	Teach tip
temperature sensor	Temperatursensor	thick gauge metal sheet	Dickblech
thin gauge metal sheet	Dünnblech	time	Zeit
tolerance	Toleranz	tool	Werkzeug
union nut	Überwurfmutter	UPS	USV
vertical adjustment (device)	Vertikaljustierung		
water connections	Wasseranschlüsse	water cooling circuit	Wasserkühlkreis
water cooling system	Wasserkühlung	water pressure	Wasserdruck
wave length range	Wellenlängenbereich	wearing part	Verschleißteil
weld defect	Schweißfehler	weld pool	Schweißbad
weld seam	Schweißnaht	welding head	Schweißkopf
welding seam quality	Schweißnahtqualität	welding spatters	Schweißspritzer
workpiece	Werkstück		

Tab. 9-2 Appendix: Technical terms (translated)



Within reach all over the world!

Please find the contact details of our
subsidiaries and representative offices at:

www.precitec.com